

**GM07 and GM08 Gaussmeter**

For Magnetic Measurement | AC and DC measurements | Tesla, A/m, A/cm, Gauss, Oersted

**FEATURES**

- Graphical LCD Display
- USB & RS232 (GM08)
- Traceable
- DC, AC, PEAK, MAX, HOLD and STORE functions
- Suitable for NDT
- Compatible with all Hirst hall probes
- Accurate traceable calibration
- 7 digit precision
- Permanent magnet measurement

Hirst Magnetic Instruments GM07 and GM08 represents the second generation of microprocessor controlled Gaussmeters using the best of Digital Signal Processing (DSP) and Analogue Techniques to offer sophisticated measuring functions in a simple to use, menu driven, hand held package. Designed for factory floor, on site and laboratory measurement of Magnetic flux Density and Magnetic Field Strength in SI or cgs, these instruments give excellent value for money.

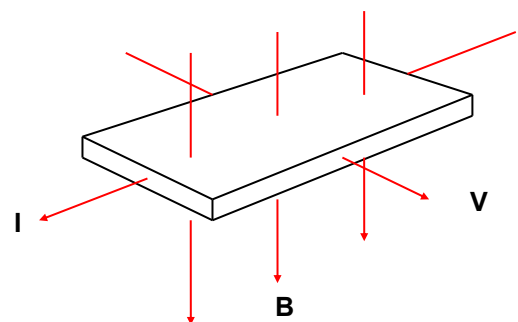
**MAGNETIC SYSTEMS FOR SCIENCE AND INDUSTRY**

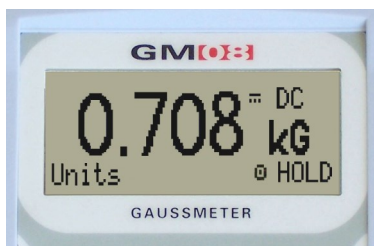
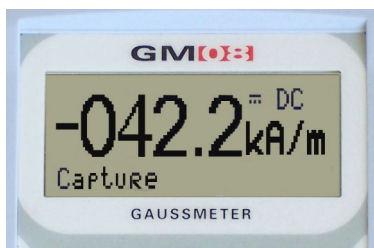
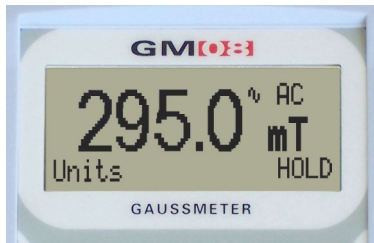
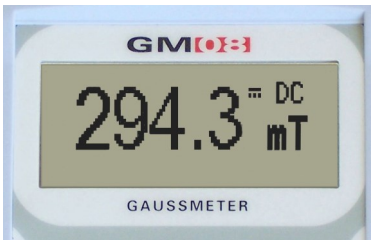
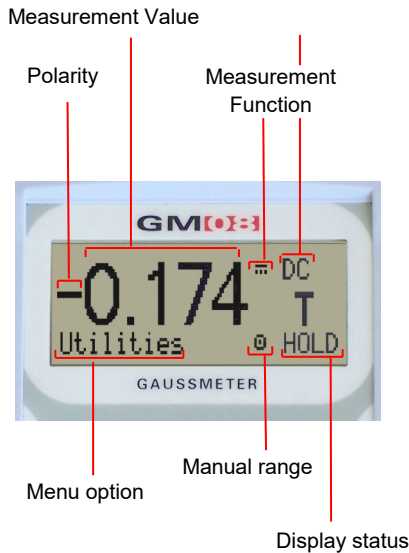

The GM08 Gaussmeter has been designed and manufactured by Hirst Magnetic Instruments Ltd. A company with more than 60 years experience in Magnetic Measurement. This experience together with our extensive knowledge of the magnetics market has enabled us to design an instrument incorporating all the measurement functions a user is likely to need. The GM08 is controlled via a simple menu and is supplied with a thin semi-flexible Transverse Hall Probe or a rigid axial probe.

## FUNCTIONS

An easy to use menu enables you to change settings which are automatically stored when you switch off. On switch on it automatically remembers its previous setting.



### Measurement functions

The GM07/O8 can measure:

DC	DC magnetic field measurement
DC PEAK	Maximum positive peak reading of the DC field
AC RMS	True RMS (Root mean Square) of input signal
AC MAX RMS	Maximum true RMS (Root mean Square)
AC PEAK	Maximum positive peak reading of the AC field

### Measurement Units

The GM08 can measure in Tesla, Amps/m, Gauss or Oersted. Saved readings can be automatically converted between measurement units.

### Data captures

The GM07/O8 can HOLD measured values by pressing the Hall Probe button. Pressing the button again releases HOLD (when enabled). The GM08 can also STORE up to 100 measurements These values can later be RECALLED, either on the Gaussmeter or via USB/RS232

### Utilities

The GM08 has a number of utilities options allowing the operator to disable or select various times for the automatic POWER DOWN. Nulling routines may also be selected.

The GM07/O8 also has a facility to operate its menu structure in English, French, Spanish, Italian, German and Portuguese

## MAGNETIC SYSTEMS FOR SCIENCE AND INDUSTRY

## Communications

The GM08 features an interface to provide USB communication, RS232 remote control of the GM08 and the uploading of measurements and data. The GM08 also incorporates a non volatile memory to enable the retention of stored values even when switched off and to retain instrument settings. The GM08 also includes a time keeping device to record the time data is stored and an external DC power supply socket for bench top applications.

## Software

Windows communication software is supplied with the GM08. This allows the user to download readings, stored data and control the instrument remotely via USB or RS232 interfaces. Data can be downloaded to Excel or open office spreadsheets, or to a CSV format file .

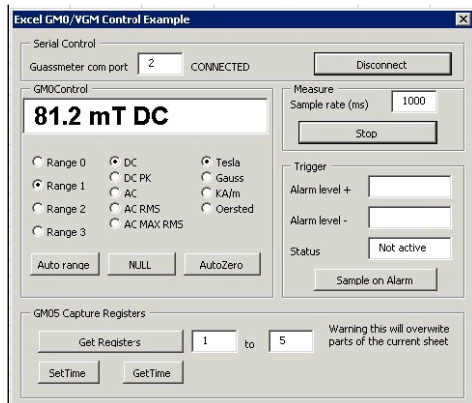

A full driver suite is available as an optional extra. This includes sample programmes with full source code (Microsoft Visual C++.NET) for the 2000 operating system, XP and later. A simple DLL allows third party integration of the GM08 into embedded systems. A labview VI is included. Linux is also supported.

## Calibration

The GM07 and GM08 is calibrated to standards traceable to the National Physical Laboratories (London UK). During manufacture, the accuracy of nuclear magnetic resonance is used to determine the irregularities and non conformities of the GM08 and its Hall Probe. This is stored and used mathematically to automatically correct readings taken by the GM07 and GM08.

## Applications

The GM07 and GM08 is ideal for inspection and measurement of magnetic flux density of magnets and magnetic assemblies in both goods inward and quality assurance environments.

Applications include:

Electric vehicle rotors

Wind turbine rotors

Non-destructive testing (magnetic)

Levels of demagnetisation in steel manufacture

Loudspeaker air gaps

Electric motor air gaps

Bending magnets Goods inward and Quality Assurance Inspection

Manual magnet calibration Any application involving AC and DC magnetic fields

## Probes

The GM07 and GM08 can be supplied with either a transverse or axial probe

### Transverse Probes:

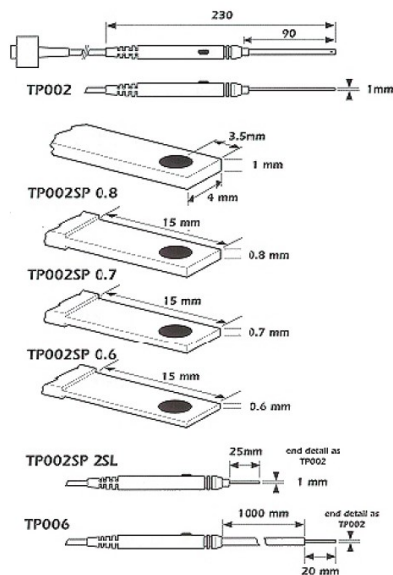

### Axial Probes:

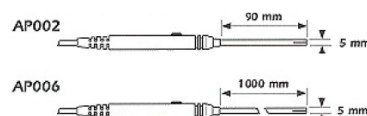

## MAGNETIC SYSTEMS FOR SCIENCE AND INDUSTRY

## SPECIFICATIONS

<b>Model</b>	GM07 and GM08
<b>SI Units</b>	0.000 - ±3.000 Tesla (00.00 - ±30.00 kiloGauss) 000.0 - ±299.9 milliTesla (0.000 - ±2.999 kiloGauss) 00.00 - ±29.99 milliTesla (000.0 - ±299.9 kiloGauss) 00.00 - ±2.999 milliTesla (00.00 - ±29.99 kiloGauss)
<b>Units of measurement</b>	Tesla, Gauss, Amps/m or Oersted
<b>Frequency Range</b>	DC and 15 Hz to 10 kHz
<b>Functions</b>	DC, DC peak, AC RMS, AC PEAK, AC MAX
<b>DC Accuracy</b>	Better than +/- 0.5% Probe and Gaussmeter max calibrated against an NMR Teslameter NPL Traceable ±1% Probe and Gaussmeter
<b>Reproducibility</b>	Better than ±0.5%
<b>Display</b>	Back lit +/- 7 digit, dedicated, transfective LCD display.
<b>Internal memory</b>	Non-volatile storage of gaussmeter settings
<b>Temperature coefficient</b>	Better than ±0.1 % of reading/°C including probe
<b>Battery Type</b>	4 x AA cells Long-life 1,5V Alkaline
<b>Temperature</b>	
- utilisation	0°C - 50°C (30°F + 125°F)
- Stockage	20°C - 70°C (70°F + 150°F)
<b>Dimensions:</b>	
- Length	175 mm (6.9 in)
- Width	89 mm (3.5 in)
- Height	40 mm (1;6 in)
<b>Weight:</b>	
(Excluding batteries)	430 g (15 oz)
<b>GM08 Features Only:</b>	
<b>USB and RS232</b>	Used for data transfer and remote control. Software handshaking. USB 1.1 Compliant
<b>Analogue Output</b>	+/-3 Volts full scale
<b>Time keeping</b>	Stored data is time stamped
<b>External PSU Socket</b>	Included -5/6V (100-500mA)
<b>PC Software</b>	Windows communication software

What you get:



GM08 Includes:

- GM08 Gaussmeter
- A choice of probe, axial or transverse
- Calibration Certificate
- Zero Flux Chamber
- USB lead
- RS232 lead
- Hard plastic carrying case

- A range of compatible specialist probes are available from the Hirst gaussmeter website

### CALIBRATION

A calibration certificate, traceable to NPL (National Physical Laboratory – UK NIM) standards, is supplied with the unit. Annual calibration is supported

Hirst Magnetic Instruments Ltd. is a company with more than 60 years of experience in magnetic measurement, manufacture, install, service and calibrate a wide range of magnetic instruments and magnetic equipment. As well as Gaussmeters, Hirst also offers Integrating Fluxmeters, Pulsed Field Magnetometers (PFMs), magnetisers, magnet calibrators, demagnetisers. In addition to standard equipment, the Hirst designs incorporate a flexible architecture, offering the simple implementation of dedicated, bespoke systems for all application.

## MAGNETIC SYSTEMS FOR SCIENCE AND INDUSTRY